

# Free Standing Acrylic Bathtub Installation Instructions

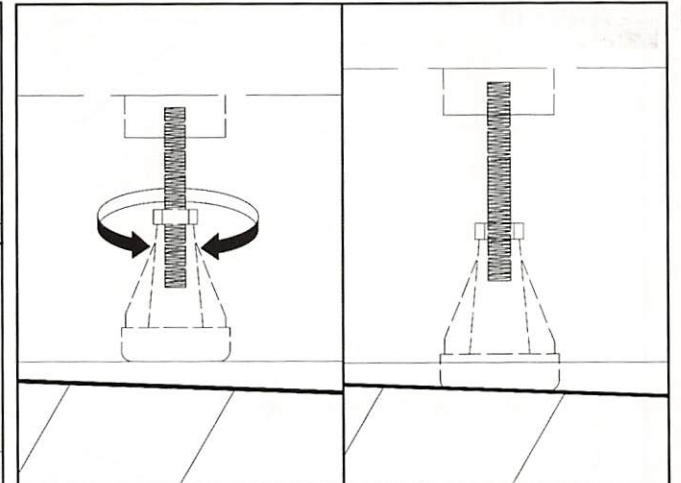
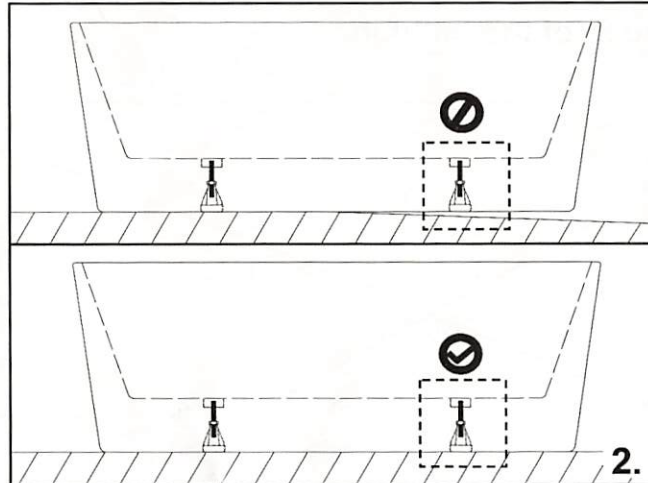
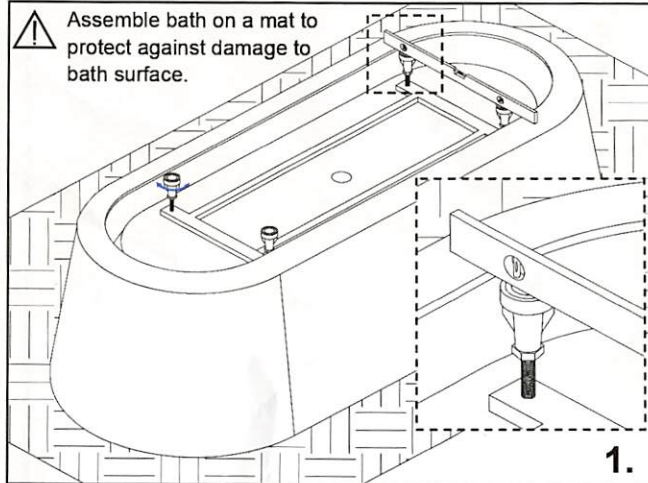

- Ensure legs are adjusted in line with the base of bath.

- Check that bath sits flat; if required adjust legs to compensate for floor level.

- ⚠ • Before step 3 set waste connection in position.

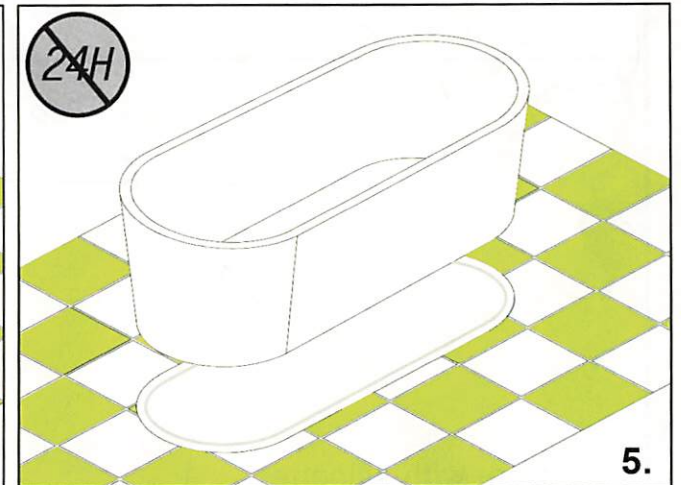
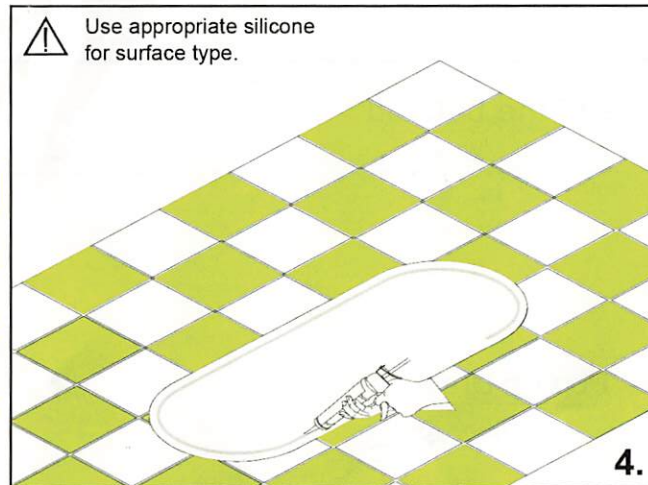
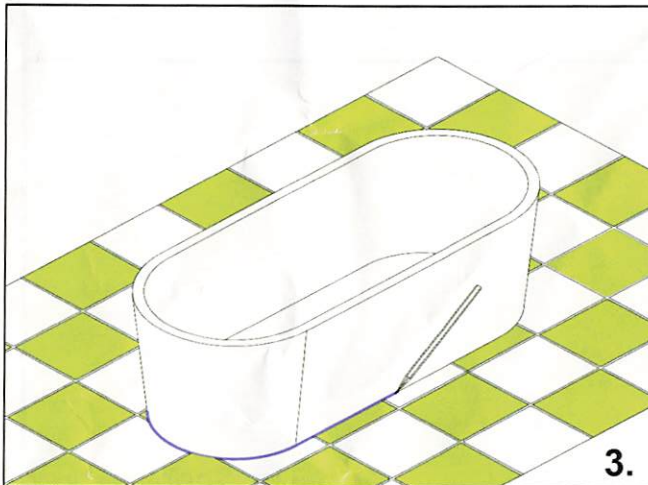

- With pencil trace outline of bath.

- Apply a thick bead of silicone within bath outline.

- Set bath in final position.

⚠ This installation guide does not include details of waste connection; final decision about installation of waste connection should be taken by a suitably qualified person.

# Free Standing Acrylic Bathtub Installation Instructions

Option1

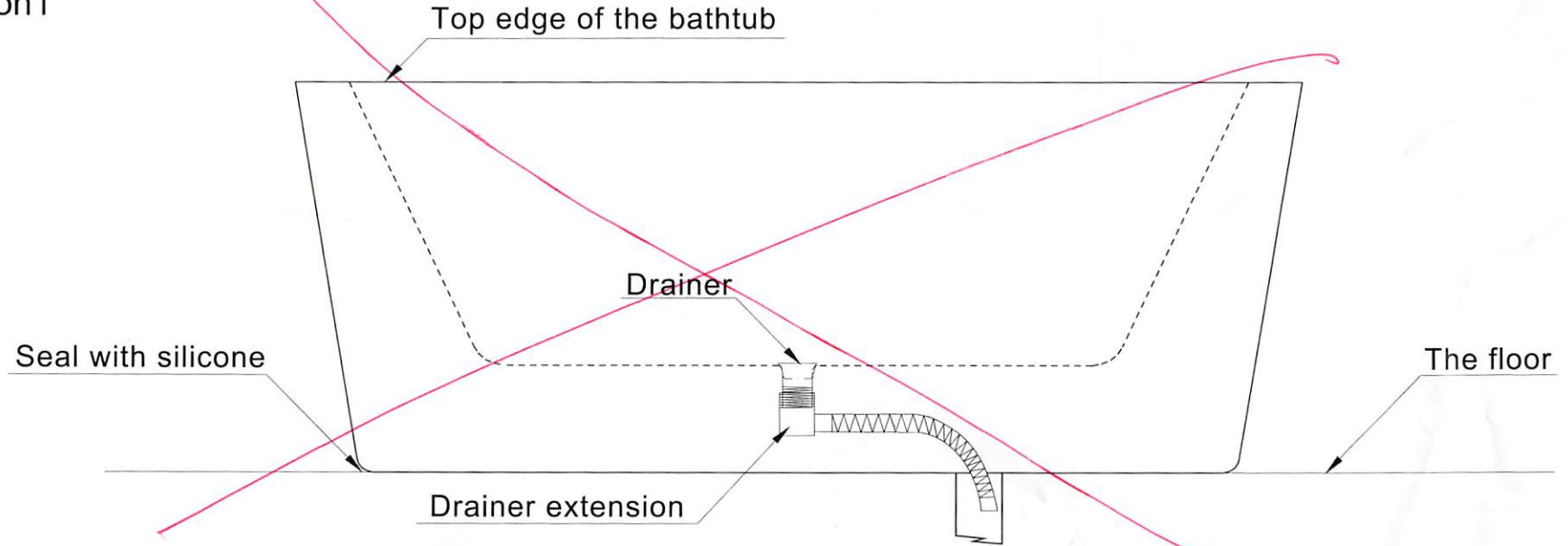

Option2

